



TYPES

- P1, P2, P3, P4

TUBES

- Horizontal, rectangular 70 x 10 mm
- Between the square tubes, a powerful convection heat exchanger is welded, consisting of steel tubes of Ø 12 x 1 mm and rectangular fins of 0,4 mm.

COLLECTORS

- 2 integrated steel collectors

COLOURS

- Standard colour white RAL 9016
- Not available in colour Gloss White
- Extensive colour chart see p. 16

SPECIAL

- Primula is available in 4 heights (70, 140, 210 and 280 mm), in 5 depths (80-130-180-230-280) and in 20 lengths (from 500 to 3900 mm).
- Type P1, P2 and P3 are also available as bench plinth radiator (suspensions from Vasco, bench not delivered from Vasco).
- An elegant covering grill is supplied as standard.
- Wall supports, telescopic floor brackets or column feet are available with price supplement (are not included in the price).
- Primula is available with designer WVO-screen of 1,5 mm steel plate. The WVO-screen is supplied separately and can easily be mounted on the plinth radiator. The WVO-screen reduces the heat loss through the window.

BRACKETS

- To be ordered separately, not included in the price of the radiator

TECHNICAL

- Electrically laser welded
- KTL priming coat, powder coating
- Standard operating pressure: 4 bar
- Extra charge for higher service pressures (10 bar): +10%.
- The delivery time of a radiator with a higher service pressure is 1 week extra.
- Maximum operating temperature: 110°C

ELECTRICAL (see chapter electrical radiators)

- ✗ Pure electrical radiator prefilled
- ✗ Mixed radiator

TECHNICAL DRAWINGS

- See p. 237

CONNECTION

- ✓ One-point connection for one-pipe system (order as special radiator) (see p. 301)
- ✓ One-point connection for two-pipe system (order as special radiator) (see p. 301)
- ✗ Two-point connection for one-pipe system
- ✓ Two-point connection for two-pipe system (standard) (see p. 300)
- ✗ Integrated valve

ABOUT PRIMULA

Heating comfort with a sense of space

Heat a room with large windows, fully in line with the interior design and the architecture is right up the street of the Primula designer plinth radiator. The sleek, horizontal lines at low altitude contribute to the desired sense of space and the high heat output, also in the minimal version, it makes the contemporary comfort complete.

RECOMMENDED CONNECTION (9999)

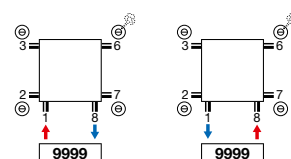

Other connection methods, see p. 236

BENCH IN OPTION



See p. 235



HOW TO ORDER P1/80

Delivery time 15 - 30 working days
(transport duration not included)

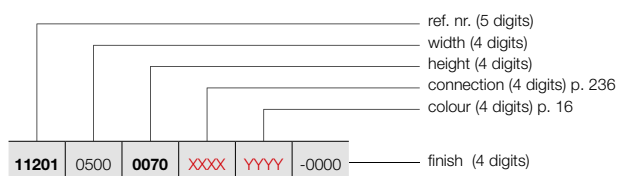

WALL BRACKET / TELESCOPIC FLOOR BRACKETS /
STEEL COLUMN FEET / WVO-SCREEN

See p. 233 for additional accessories.

PRIMULA P1 (P1/80)



P1

REFERENCE CODE CUSTOM MADE P1	TECHNICAL DATA									
	tubes	width (L mm)	height (H mm)	75/65/20 (Watt)	55/45/20 (Watt)	n-exp.	weight (kg)	water content (l)	electr. resistance (Watt)	
REF. NR. P1 P1/80 : 11201										
11201 0500 0070 XXXX YYYY -0000	-	500	70	203	101	1,36	3,07	0,66	-	
11201 0600 0070 XXXX YYYY -0000	-	600	70	243	121	1,36	3,68	0,79	-	
11201 0700 0070 XXXX YYYY -0000	-	700	70	284	142	1,36	4,29	0,92	-	
11201 0800 0070 XXXX YYYY -0000	-	800	70	324	162	1,36	4,90	1,05	-	
11201 0900 0070 XXXX YYYY -0000	-	900	70	365	182	1,36	5,52	1,18	-	
11201 1000 0070 XXXX YYYY -0000	-	1000	70	405	202	1,36	6,13	1,31	-	
11201 1100 0070 XXXX YYYY -0000	-	1100	70	446	223	1,36	6,74	1,44	-	
11201 1200 0070 XXXX YYYY -0000	-	1200	70	486	243	1,36	7,36	1,57	-	
11201 1400 0070 XXXX YYYY -0000	-	1400	70	567	283	1,36	8,58	1,83	-	
11201 1600 0070 XXXX YYYY -0000	-	1600	70	648	323	1,36	9,81	2,10	-	
11201 1800 0070 XXXX YYYY -0000	-	1800	70	729	364	1,36	11,03	2,36	-	
11201 2000 0070 XXXX YYYY -0000	-	2000	70	810	404	1,36	12,26	2,62	-	
11201 2200 0070 XXXX YYYY -0000	-	2200	70	891	445	1,36	13,49	2,88	-	
11201 2400 0070 XXXX YYYY -0000	-	2400	70	972	485	1,36	14,71	3,14	-	
11201 2600 0070 XXXX YYYY -0000	-	2600	70	1053	526	1,36	15,94	3,41	-	
11201 2800 0070 XXXX YYYY -0000	-	2800	70	1134	566	1,36	17,16	3,67	-	
11201 3000 0070 XXXX YYYY -0000	-	3000	70	1215	607	1,36	18,39	3,93	-	
11201 3300 0070 XXXX YYYY -0000	-	3300	70	1337	667	1,36	20,23	4,32	-	
11201 3600 0070 XXXX YYYY -0000	-	3600	70	1458	728	1,36	22,07	4,72	-	
11201 3900 0070 XXXX YYYY -0000	-	3900	70	1580	789	1,36	23,91	5,11	-	

CE 05 in conformity with EN442-1: radiators and convectors

For heat outputs in other regimes, see p. 308 (correction factors)

PRIMULA P1 (P1/130)



P1

HOW TO ORDER P1/130

Delivery time 15 - 30 working days
(transport duration not included)

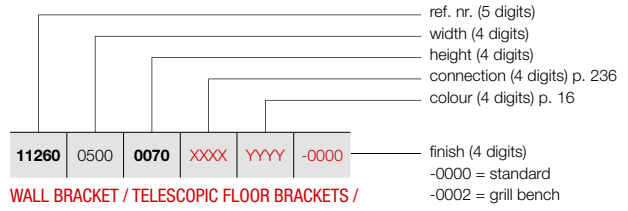

**WALL BRACKET / TELESCOPIC FLOOR BRACKETS /
STEEL COLUMN FEET / WVO-SCREEN / BENCH**

See p. 233 for additional accessories.

REFERENCE CODE CUSTOM MADE P1	TECHNICAL DATA									
	tubes	width (L mm)	height (H mm)	75/65/20 (Watt)	55/45/20 (Watt)	n-exp.	weight (kg)	water content (l)	electr. resistance (Watt)	
REF. NR. P1 P1/130 : 11260										
11260 0500 0070 XXXX YYYY -0000	-	500	70	312	156	1,36	4,33	0,88	-	
11260 0600 0070 XXXX YYYY -0000	-	600	70	374	187	1,36	5,19	1,05	-	
11260 0700 0070 XXXX YYYY -0000	-	700	70	437	218	1,36	6,06	1,23	-	
11260 0800 0070 XXXX YYYY -0000	-	800	70	499	249	1,36	6,92	1,40	-	
11260 0900 0070 XXXX YYYY -0000	-	900	70	562	281	1,36	7,79	1,58	-	
11260 1000 0070 XXXX YYYY -0000	-	1000	70	624	312	1,36	8,65	1,75	-	
11260 1100 0070 XXXX YYYY -0000	-	1100	70	686	342	1,36	9,52	1,93	-	
11260 1200 0070 XXXX YYYY -0000	-	1200	70	749	374	1,36	10,38	2,10	-	
11260 1400 0070 XXXX YYYY -0000	-	1400	70	874	436	1,36	12,11	2,45	-	
11260 1600 0070 XXXX YYYY -0000	-	1600	70	998	498	1,36	13,84	2,80	-	
11260 1800 0070 XXXX YYYY -0000	-	1800	70	1123	561	1,36	15,57	3,15	-	
11260 2000 0070 XXXX YYYY -0000	-	2000	70	1248	623	1,36	17,30	3,50	-	
11260 2200 0070 XXXX YYYY -0000	-	2200	70	1373	685	1,36	19,03	3,85	-	
11260 2400 0070 XXXX YYYY -0000	-	2400	70	1498	748	1,36	20,76	4,20	-	
11260 2600 0070 XXXX YYYY -0000	-	2600	70	1622	810	1,36	22,49	4,55	-	
11260 2800 0070 XXXX YYYY -0000	-	2800	70	1747	872	1,36	24,22	4,90	-	
11260 3000 0070 XXXX YYYY -0000	-	3000	70	1872	935	1,36	25,95	5,25	-	
11260 3300 0070 XXXX YYYY -0000	-	3300	70	2059	1028	1,36	28,55	5,78	-	
11260 3600 0070 XXXX YYYY -0000	-	3600	70	2246	1121	1,36	31,14	6,30	-	
11260 3900 0070 XXXX YYYY -0000	-	3900	70	2434	1215	1,36	33,74	6,83	-	

CE₀₅ in conformity with EN442-1: radiators and convectors

For heat outputs in other regimes, see p. 308 (correction factors)

HOW TO ORDER P1/180

Delivery time 15 - 30 working days
(transport duration not included)

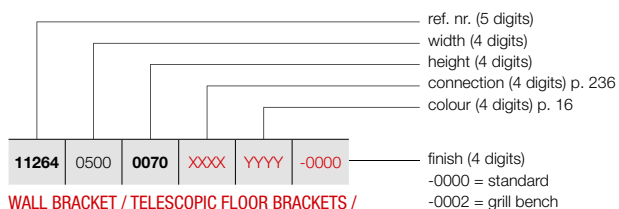

11264 | 0500 | **0070** | XXXX | YYYY | -0000

finish (4 digits)
-0000 = standard
-0002 = grill bench

**WALL BRACKET / TELESCOPIC FLOOR BRACKETS /
STEEL COLUMN FEET / WVO-SCREEN / BENCH**

See p. 233 for additional accessories.

PRIMULA P1 (P1/180)



P1

REFERENCE CODE CUSTOM MADE P1	TECHNICAL DATA									
	tubes	width (L mm)	height (H mm)	75/65/20 (Watt)	55/45/20 (Watt)	n-exp.	weight (kg)	water content (l)	electr. resistance (Watt)	
REF. NR. P1 P1/180 : 11264										
11264 0500 0070 XXXX YYYY -0000	-	500	70	422	212	1,35	5,70	1,05	-	
11264 0600 0070 XXXX YYYY -0000	-	600	70	506	254	1,35	6,84	1,26	-	
11264 0700 0070 XXXX YYYY -0000	-	700	70	590	296	1,35	7,98	1,47	-	
11264 0800 0070 XXXX YYYY -0000	-	800	70	674	338	1,35	9,12	1,68	-	
11264 0900 0070 XXXX YYYY -0000	-	900	70	759	381	1,35	10,26	1,89	-	
11264 1000 0070 XXXX YYYY -0000	-	1000	70	843	423	1,35	11,40	2,10	-	
11264 1100 0070 XXXX YYYY -0000	-	1100	70	927	465	1,35	12,54	2,31	-	
11264 1200 0070 XXXX YYYY -0000	-	1200	70	1012	508	1,35	13,68	2,52	-	
11264 1400 0070 XXXX YYYY -0000	-	1400	70	1180	592	1,35	15,96	2,94	-	
11264 1600 0070 XXXX YYYY -0000	-	1600	70	1349	677	1,35	18,24	3,36	-	
11264 1800 0070 XXXX YYYY -0000	-	1800	70	1517	761	1,35	20,52	3,78	-	
11264 2000 0070 XXXX YYYY -0000	-	2000	70	1686	846	1,35	22,80	4,20	-	
11264 2200 0070 XXXX YYYY -0000	-	2200	70	1855	931	1,35	25,08	4,62	-	
11264 2400 0070 XXXX YYYY -0000	-	2400	70	2023	1015	1,35	27,36	5,04	-	
11264 2600 0070 XXXX YYYY -0000	-	2600	70	2192	1100	1,35	29,64	5,46	-	
11264 2800 0070 XXXX YYYY -0000	-	2800	70	2360	1184	1,35	31,92	5,88	-	
11264 3000 0070 XXXX YYYY -0000	-	3000	70	2529	1269	1,35	34,20	6,30	-	
11264 3300 0070 XXXX YYYY -0000	-	3300	70	2782	1396	1,35	37,62	6,93	-	
11264 3600 0070 XXXX YYYY -0000	-	3600	70	3035	1523	1,35	41,04	7,56	-	
11264 3900 0070 XXXX YYYY -0000	-	3900	70	3288	1650	1,35	44,46	8,19	-	

CE 05 in conformity with EN442-1: radiators and convectors

For heat outputs in other regimes, see p. 308 (correction factors)

PRIMULA P1 (P1/230)



P1

HOW TO ORDER P1/230

Delivery time 15 - 30 working days
(transport duration not included)

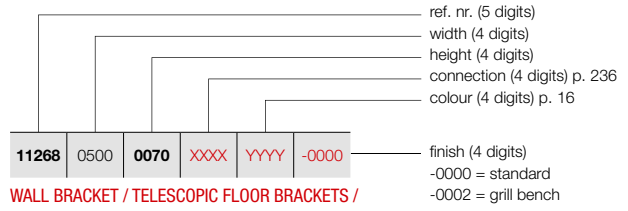

WALL BRACKET / TELESCOPIC FLOOR BRACKETS /
STEEL COLUMN FEET / WVO-SCREEN / BENCH

See p. 233 for additional accessories.

REFERENCE CODE CUSTOM MADE P1	TECHNICAL DATA									
	tubes	width (L mm)	height (H mm)	75/65/20 (Watt)	55/45/20 (Watt)	n-exp.	weight (kg)	water content (l)	electr. resistance (Watt)	
REF. NR. P1 P1/230 : 11268										
11268 0500 0070 XXXX YYYY -0000	-	500	70	523	258	1,38	6,90	1,20	-	
11268 0600 0070 XXXX YYYY -0000	-	600	70	627	310	1,38	8,28	1,44	-	
11268 0700 0070 XXXX YYYY -0000	-	700	70	732	362	1,38	9,66	1,68	-	
11268 0800 0070 XXXX YYYY -0000	-	800	70	836	413	1,38	11,04	1,92	-	
11268 0900 0070 XXXX YYYY -0000	-	900	70	941	465	1,38	12,42	2,16	-	
11268 1000 0070 XXXX YYYY -0000	-	1000	70	1045	516	1,38	13,80	2,40	-	
11268 1100 0070 XXXX YYYY -0000	-	1100	70	1150	568	1,38	15,18	2,64	-	
11268 1200 0070 XXXX YYYY -0000	-	1200	70	1254	620	1,38	16,56	2,88	-	
11268 1400 0070 XXXX YYYY -0000	-	1400	70	1463	723	1,38	19,32	3,36	-	
11268 1600 0070 XXXX YYYY -0000	-	1600	70	1672	826	1,38	22,08	3,84	-	
11268 1800 0070 XXXX YYYY -0000	-	1800	70	1881	929	1,38	24,84	4,32	-	
11268 2000 0070 XXXX YYYY -0000	-	2000	70	2090	1033	1,38	27,60	4,80	-	
11268 2200 0070 XXXX YYYY -0000	-	2200	70	2299	1136	1,38	30,36	5,28	-	
11268 2400 0070 XXXX YYYY -0000	-	2400	70	2508	1239	1,38	33,12	5,76	-	
11268 2600 0070 XXXX YYYY -0000	-	2600	70	2717	1343	1,38	35,88	6,24	-	
11268 2800 0070 XXXX YYYY -0000	-	2800	70	2926	1446	1,38	38,64	6,72	-	
11268 3000 0070 XXXX YYYY -0000	-	3000	70	3135	1549	1,38	41,40	7,20	-	
11268 3300 0070 XXXX YYYY -0000	-	3300	70	3449	1704	1,38	45,54	7,92	-	
11268 3600 0070 XXXX YYYY -0000	-	3600	70	3762	1859	1,38	49,68	8,64	-	
11268 3900 0070 XXXX YYYY -0000	-	3900	70	4076	2014	1,38	53,82	9,36	-	

CE₀₅ in conformity with EN442-1: radiators and convectors

For heat outputs in other regimes, see p. 308 (correction factors)

HOW TO ORDER P1/280

Delivery time 15 - 30 working days
(transport duration not included)

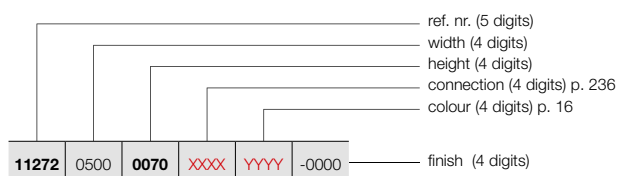

WALL BRACKET / TELESCOPIC FLOOR BRACKETS /
STEEL COLUMN FEET / WVO-SCREEN

See p. 233 for additional accessories.

PRIMULA P1 (P1/280)



P1

REFERENCE CODE CUSTOM MADE P1	TECHNICAL DATA									
	tubes	width (L mm)	height (H mm)	75/65/20 (Watt)	55/45/20 (Watt)	n-exp.	weight (kg)	water content (l)	electr. resistance (Watt)	
REF. NR. P1 P1/280 : 11272										
11272 0500 0070 XXXX YYYY -0000	-	500	70	630	315	1,36	8,00	1,40	-	
11272 0600 0070 XXXX YYYY -0000	-	600	70	756	377	1,36	9,60	1,68	-	
11272 0700 0070 XXXX YYYY -0000	-	700	70	882	440	1,36	11,20	1,96	-	
11272 0800 0070 XXXX YYYY -0000	-	800	70	1008	503	1,36	12,80	2,24	-	
11272 0900 0070 XXXX YYYY -0000	-	900	70	1134	566	1,36	14,40	2,52	-	
11272 1000 0070 XXXX YYYY -0000	-	1000	70	1260	629	1,36	16,00	2,80	-	
11272 1100 0070 XXXX YYYY -0000	-	1100	70	1386	692	1,36	17,60	3,08	-	
11272 1200 0070 XXXX YYYY -0000	-	1200	70	1512	755	1,36	19,20	3,36	-	
11272 1400 0070 XXXX YYYY -0000	-	1400	70	1764	881	1,36	22,40	3,92	-	
11272 1600 0070 XXXX YYYY -0000	-	1600	70	2016	1006	1,36	25,60	4,48	-	
11272 1800 0070 XXXX YYYY -0000	-	1800	70	2268	1132	1,36	28,80	5,04	-	
11272 2000 0070 XXXX YYYY -0000	-	2000	70	2520	1258	1,36	32,00	5,60	-	
11272 2200 0070 XXXX YYYY -0000	-	2200	70	2772	1384	1,36	35,20	6,16	-	
11272 2400 0070 XXXX YYYY -0000	-	2400	70	3024	1510	1,36	38,40	6,72	-	
11272 2600 0070 XXXX YYYY -0000	-	2600	70	3276	1635	1,36	41,60	7,28	-	
11272 2800 0070 XXXX YYYY -0000	-	2800	70	3528	1761	1,36	44,80	7,84	-	
11272 3000 0070 XXXX YYYY -0000	-	3000	70	3780	1887	1,36	48,00	8,40	-	
11272 3300 0070 XXXX YYYY -0000	-	3300	70	4158	2076	1,36	52,80	9,24	-	
11272 3600 0070 XXXX YYYY -0000	-	3600	70	4536	2264	1,36	57,60	10,08	-	
11272 3900 0070 XXXX YYYY -0000	-	3900	70	4914	2453	1,36	62,40	10,92	-	

CE 05 in conformity with EN442-1: radiators and convectors

For heat outputs in other regimes, see p. 308 (correction factors)

PRIMULA P2 (P2/80)



P2

HOW TO ORDER P2/80

Delivery time 15 - 30 working days
(transport duration not included)

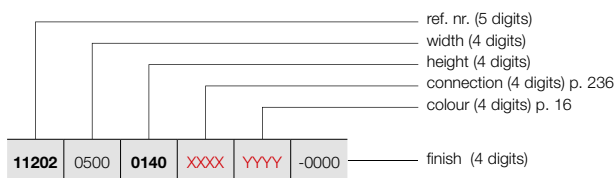

**WALL BRACKET / TELESCOPIC FLOOR BRACKETS /
STEEL COLUMN FEET / WVO-SCREEN**

See p. 233 for additional accessories.

REFERENCE CODE CUSTOM MADE P2						TECHNICAL DATA									
						tubes	width (L mm)	height (H mm)	75/65/20 (Watt)	55/45/20 (Watt)	n-exp.	weight (kg)	water content (l)	electr. resistance (Watt)	
REF. NR. P2 P2/80 : 11202															
11202	0500	0140	XXXX	YYYY	-0000	-	500	140	304	153	1,35	5,73	1,46	-	
11202	0600	0140	XXXX	YYYY	-0000	-	600	140	365	183	1,35	6,88	1,75	-	
11202	0700	0140	XXXX	YYYY	-0000	-	700	140	426	214	1,35	8,02	2,04	-	
11202	0800	0140	XXXX	YYYY	-0000	-	800	140	486	244	1,35	9,17	2,33	-	
11202	0900	0140	XXXX	YYYY	-0000	-	900	140	547	274	1,35	10,31	2,62	-	
11202	1000	0140	XXXX	YYYY	-0000	-	1000	140	608	305	1,35	11,46	2,91	-	
11202	1100	0140	XXXX	YYYY	-0000	-	1100	140	669	336	1,35	12,61	3,20	-	
11202	1200	0140	XXXX	YYYY	-0000	-	1200	140	730	366	1,35	13,75	3,49	-	
11202	1400	0140	XXXX	YYYY	-0000	-	1400	140	851	427	1,35	16,04	4,07	-	
11202	1600	0140	XXXX	YYYY	-0000	-	1600	140	973	488	1,35	18,34	4,66	-	
11202	1800	0140	XXXX	YYYY	-0000	-	1800	140	1094	549	1,35	20,63	5,24	-	
11202	2000	0140	XXXX	YYYY	-0000	-	2000	140	1216	610	1,35	22,92	5,82	-	
11202	2200	0140	XXXX	YYYY	-0000	-	2200	140	1338	671	1,35	25,21	6,40	-	
11202	2400	0140	XXXX	YYYY	-0000	-	2400	140	1459	732	1,35	27,50	6,98	-	
11202	2600	0140	XXXX	YYYY	-0000	-	2600	140	1581	793	1,35	29,80	7,57	-	
11202	2800	0140	XXXX	YYYY	-0000	-	2800	140	1702	854	1,35	32,09	8,15	-	
11202	3000	0140	XXXX	YYYY	-0000	-	3000	140	1824	915	1,35	34,38	8,73	-	
11202	3300	0140	XXXX	YYYY	-0000	-	3300	140	2006	1007	1,35	37,82	9,60	-	
11202	3600	0140	XXXX	YYYY	-0000	-	3600	140	2189	1098	1,35	41,26	10,48	-	
11202	3900	0140	XXXX	YYYY	-0000	-	3900	140	2371	1190	1,35	44,69	11,35	-	

CE₀₅ in conformity with EN442-1: radiators and convectors

For heat outputs in other regimes, see p. 308 (correction factors)

HOW TO ORDER P2/130

Delivery time 15 - 30 working days
(transport duration not included)

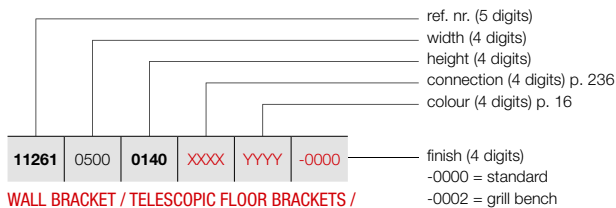

11261 0500 0140 XXXX YYYY -0000

finish (4 digits)
-0000 = standard
-0002 = grill bench

WALL BRACKET / TELESCOPIC FLOOR BRACKETS / STEEL COLUMN FEET / WVO-SCREEN / BENCH
See p. 233 for additional accessories.

HOW TO ORDER STOCK RADIATOR P2/130

Delivery time 5 working days
(transport duration not included)

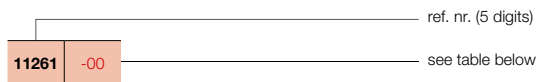

P2

REFERENCE CODE CUSTOM MADE P2							TECHNICAL DATA								
							tubes	width (L mm)	height (H mm)	75/65/20 (Watt)	55/45/20 (Watt)	n-exp.	weight (kg)	water content (l)	electr. resistance (Watt)
REF. NR. P2 P2/130 : 11261															
11261	0500	0140	XXXX	YYYY	-0000	-	500	140	442	221	1,36	7,77	1,87	-	-
11261	0600	0140	XXXX	YYYY	-0000	-	600	140	530	265	1,36	9,32	2,24	-	-
11261	0700	0140	XXXX	YYYY	-0000	-	700	140	619	309	1,36	10,87	2,61	-	-
11261	0800	0140	XXXX	YYYY	-0000	-	800	140	707	353	1,36	12,42	2,98	-	11261-01
11261	0900	0140	XXXX	YYYY	-0000	-	900	140	796	397	1,36	13,98	3,36	-	-
11261	1000	0140	XXXX	YYYY	-0000	-	1000	140	884	441	1,36	15,53	3,73	-	11261-02
11261	1100	0140	XXXX	YYYY	-0000	-	1100	140	972	485	1,36	17,08	4,10	-	-
11261	1200	0140	XXXX	YYYY	-0000	-	1200	140	1061	530	1,36	18,64	4,48	-	11261-03
11261	1400	0140	XXXX	YYYY	-0000	-	1400	140	1238	618	1,36	21,74	5,22	-	11261-04
11261	1600	0140	XXXX	YYYY	-0000	-	1600	140	1414	706	1,36	24,85	5,97	-	11261-05
11261	1800	0140	XXXX	YYYY	-0000	-	1800	140	1591	794	1,36	27,95	6,71	-	-
11261	2000	0140	XXXX	YYYY	-0000	-	2000	140	1768	883	1,36	31,06	7,46	-	11261-07
11261	2200	0140	XXXX	YYYY	-0000	-	2200	140	1945	971	1,36	34,17	8,21	-	-
11261	2400	0140	XXXX	YYYY	-0000	-	2400	140	2122	1059	1,36	37,27	8,95	-	-
11261	2600	0140	XXXX	YYYY	-0000	-	2600	140	2298	1147	1,36	40,38	9,70	-	-
11261	2800	0140	XXXX	YYYY	-0000	-	2800	140	2475	1236	1,36	43,48	10,44	-	-
11261	3000	0140	XXXX	YYYY	-0000	-	3000	140	2652	1324	1,36	46,59	11,19	-	11261-10
11261	3300	0140	XXXX	YYYY	-0000	-	3300	140	2917	1456	1,36	51,25	12,31	-	-
11261	3600	0140	XXXX	YYYY	-0000	-	3600	140	3182	1588	1,36	55,91	13,43	-	-
11261	3900	0140	XXXX	YYYY	-0000	-	3900	140	3448	1721	1,36	60,57	14,55	-	-

CE 05 in conformity with EN442-1: radiators and convectors

For heat outputs in other regimes, see p. 308 (correction factors)

PRIMULA P2 (P2/180)



P2

HOW TO ORDER P2/180

Delivery time 15 - 30 working days
(transport duration not included)

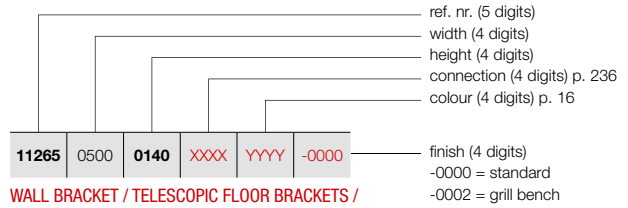

WALL BRACKET / TELESCOPIC FLOOR BRACKETS / STEEL COLUMN FEET / WVO-SCREEN / BENCH

See p. 233 for additional accessories.

HOW TO ORDER STOCK RADIATOR P2/180

Delivery time 5 working days
(transport duration not included)

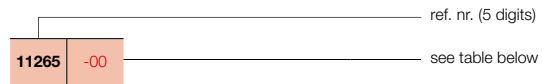

REFERENCE CODE CUSTOM MADE P2							TECHNICAL DATA								short ref. nr.
11265	width (L mm)	0140	height (H mm)	75/65/20 (Watt)	55/45/20 (Watt)	n-exp.	weight (kg)	water content (l)	electr. resistance (Watt)	RAL 9016 stock					
REF. NR. P2 P2/180 : 11265															
11265	0500	0140	140	611	305	1,36	9,90	2,23	-	-					
11265	0600	0140	140	733	366	1,36	11,88	2,67	-	-					
11265	0700	0140	140	855	427	1,36	13,86	3,12	-	-					
11265	0800	0140	140	977	488	1,36	15,84	3,56	-	-					
11265	0900	0140	140	1099	549	1,36	17,82	4,01	-	-					
11265	1000	0140	140	1221	610	1,36	19,80	4,45	-	-					
11265	1100	0140	140	1343	670	1,36	21,78	4,90	-	-					
11265	1200	0140	140	1465	731	1,36	23,76	5,34	-	11265-02					
11265	1400	0140	140	1709	853	1,36	27,72	6,23	-	-					
11265	1600	0140	140	1954	975	1,36	31,68	7,12	-	11265-04					
11265	1800	0140	140	2198	1097	1,36	35,64	8,01	-	-					
11265	2000	0140	140	2442	1219	1,36	39,60	8,90	-	-					
11265	2200	0140	140	2686	1341	1,36	43,56	9,79	-	-					
11265	2400	0140	140	2930	1463	1,36	47,52	10,68	-	11265-07					
11265	2600	0140	140	3175	1585	1,36	51,48	11,57	-	-					
11265	2800	0140	140	3419	1707	1,36	55,44	12,46	-	-					
11265	3000	0140	140	3663	1829	1,36	59,40	13,35	-	-					
11265	3300	0140	140	4029	2011	1,36	65,34	14,69	-	-					
11265	3600	0140	140	4396	2195	1,36	71,28	16,02	-	-					
11265	3900	0140	140	4762	2377	1,36	77,22	17,36	-	-					

CE₀₅ in conformity with EN442-1: radiators and convectors

For heat outputs in other regimes, see p. 308 (correction factors)

HOW TO ORDER P2/230

Delivery time 15 - 30 working days
(transport duration not included)

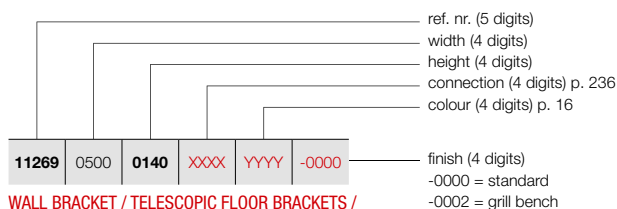

**WALL BRACKET / TELESCOPIC FLOOR BRACKETS /
STEEL COLUMN FEET / WVO-SCREEN / BENCH**

See p. 233 for additional accessories.

PRIMULA P2 (P2/230)



P2

REFERENCE CODE CUSTOM MADE P2	TECHNICAL DATA													
	tubes	width (L mm)	height (H mm)	75/65/20 (Watt)	55/45/20 (Watt)	n-exp.	weight (kg)	water content (l)	electr. resistance (Watt)					
REF. NR. P2 P2/230 : 11269														
11269	0500	0140	XXXX	YYYY	-0000	-	500	140	756	375	1,37	11,88	2,73	-
11269	0600	0140	XXXX	YYYY	-0000	-	600	140	907	450	1,37	14,25	3,27	-
11269	0700	0140	XXXX	YYYY	-0000	-	700	140	1058	525	1,37	16,63	3,82	-
11269	0800	0140	XXXX	YYYY	-0000	-	800	140	1209	600	1,37	19,00	4,36	-
11269	0900	0140	XXXX	YYYY	-0000	-	900	140	1360	675	1,37	21,38	4,91	-
11269	1000	0140	XXXX	YYYY	-0000	-	1000	140	1511	750	1,37	23,75	5,45	-
11269	1100	0140	XXXX	YYYY	-0000	-	1100	140	1662	825	1,37	26,13	6,00	-
11269	1200	0140	XXXX	YYYY	-0000	-	1200	140	1813	900	1,37	28,50	6,54	-
11269	1400	0140	XXXX	YYYY	-0000	-	1400	140	2115	1050	1,37	33,25	7,63	-
11269	1600	0140	XXXX	YYYY	-0000	-	1600	140	2418	1201	1,37	38,00	8,72	-
11269	1800	0140	XXXX	YYYY	-0000	-	1800	140	2720	1351	1,37	42,75	9,81	-
11269	2000	0140	XXXX	YYYY	-0000	-	2000	140	3022	1501	1,37	47,50	10,90	-
11269	2200	0140	XXXX	YYYY	-0000	-	2200	140	3324	1651	1,37	52,25	11,99	-
11269	2400	0140	XXXX	YYYY	-0000	-	2400	140	3626	1801	1,37	57,00	13,08	-
11269	2600	0140	XXXX	YYYY	-0000	-	2600	140	3929	1951	1,37	61,75	14,17	-
11269	2800	0140	XXXX	YYYY	-0000	-	2800	140	4231	2101	1,37	66,50	15,26	-
11269	3000	0140	XXXX	YYYY	-0000	-	3000	140	4533	2251	1,37	71,25	16,35	-
11269	3300	0140	XXXX	YYYY	-0000	-	3300	140	4986	2476	1,37	78,38	17,99	-
11269	3600	0140	XXXX	YYYY	-0000	-	3600	140	5440	2702	1,37	85,50	19,62	-
11269	3900	0140	XXXX	YYYY	-0000	-	3900	140	5893	2927	1,37	92,63	21,26	-

CE 05 in conformity with EN442-1: radiators and convectors

For heat outputs in other regimes, see p. 308 (correction factors)

PRIMULA P2 (P2/280)



P2

HOW TO ORDER P2/280

Delivery time 15 - 30 working days
(transport duration not included)

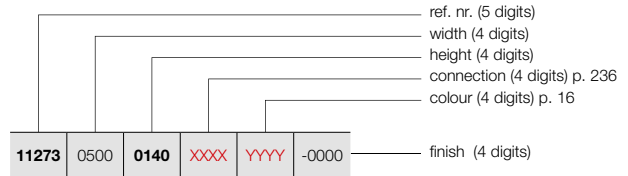

WALL BRACKET / TELESCOPIC FLOOR BRACKETS /
STEEL COLUMN FEET / WVO-SCREEN

See p. 233 for additional accessories.

REFERENCE CODE CUSTOM MADE P2						TECHNICAL DATA								
11273	width (L mm)	0140	XXXX	YYYY	-0000	tubes	width (L mm)	height (H mm)	75/65/20 (Watt)	55/45/20 (Watt)	n-exp.	weight (kg)	water content (l)	electr. resistance (Watt)
REF. NR. P2 P2/280 : 11273														
11273	0500	0140	XXXX	YYYY	-0000	-	500	140	953	473	1,37	13,85	2,98	-
11273	0600	0140	XXXX	YYYY	-0000	-	600	140	1143	568	1,37	16,62	3,57	-
11273	0700	0140	XXXX	YYYY	-0000	-	700	140	1334	663	1,37	19,39	4,17	-
11273	0800	0140	XXXX	YYYY	-0000	-	800	140	1524	757	1,37	22,16	4,76	-
11273	0900	0140	XXXX	YYYY	-0000	-	900	140	1715	852	1,37	24,93	5,36	-
11273	1000	0140	XXXX	YYYY	-0000	-	1000	140	1905	946	1,37	27,70	5,95	-
11273	1100	0140	XXXX	YYYY	-0000	-	1100	140	2096	1041	1,37	30,47	6,55	-
11273	1200	0140	XXXX	YYYY	-0000	-	1200	140	2286	1135	1,37	33,24	7,14	-
11273	1400	0140	XXXX	YYYY	-0000	-	1400	140	2667	1325	1,37	38,78	8,33	-
11273	1600	0140	XXXX	YYYY	-0000	-	1600	140	3048	1514	1,37	44,32	9,52	-
11273	1800	0140	XXXX	YYYY	-0000	-	1800	140	3429	1703	1,37	49,86	10,71	-
11273	2000	0140	XXXX	YYYY	-0000	-	2000	140	3810	1892	1,37	55,40	11,90	-
11273	2200	0140	XXXX	YYYY	-0000	-	2200	140	4191	2082	1,37	60,94	13,09	-
11273	2400	0140	XXXX	YYYY	-0000	-	2400	140	4572	2271	1,37	66,48	14,28	-
11273	2600	0140	XXXX	YYYY	-0000	-	2600	140	4953	2460	1,37	72,02	15,47	-
11273	2800	0140	XXXX	YYYY	-0000	-	2800	140	5334	2649	1,37	77,56	16,66	-
11273	3000	0140	XXXX	YYYY	-0000	-	3000	140	5715	2838	1,37	83,10	17,85	-
11273	3300	0140	XXXX	YYYY	-0000	-	3300	140	6287	3123	1,37	91,41	19,64	-
11273	3600	0140	XXXX	YYYY	-0000	-	3600	140	6858	3406	1,37	99,72	21,42	-
11273	3900	0140	XXXX	YYYY	-0000	-	3900	140	7430	3690	1,37	108,03	23,21	-

CE₀₅ in conformity with EN442-1: radiators and convectors

For heat outputs in other regimes, see p. 308 (correction factors)

HOW TO ORDER P3/80

Delivery time 15 - 30 working days
(transport duration not included)

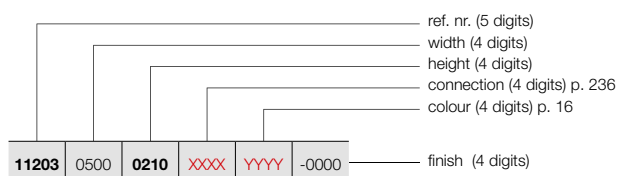

WALL BRACKET / TELESCOPIC FLOOR BRACKETS /
STEEL COLUMN FEET / WVO-SCREEN

See p. 233 for additional accessories.

PRIMULA P3 (P3/80)



P3

REFERENCE CODE CUSTOM MADE P3	TECHNICAL DATA									
	tubes	width (L mm)	height (H mm)	75/65/20 (Watt)	55/45/20 (Watt)	n-exp.	weight (kg)	water content (l)	electr. resistance (Watt)	
REF. NR. P3 P3/80 : 11203										
11203 0500 0210 XXXX YYYY -0000	-	500	210	378	190	1,35	8,40	2,25	-	
11203 0600 0210 XXXX YYYY -0000	-	600	210	454	228	1,35	10,08	2,70	-	
11203 0700 0210 XXXX YYYY -0000	-	700	210	529	265	1,35	11,76	3,15	-	
11203 0800 0210 XXXX YYYY -0000	-	800	210	605	304	1,35	13,44	3,60	-	
11203 0900 0210 XXXX YYYY -0000	-	900	210	680	341	1,35	15,12	4,05	-	
11203 1000 0210 XXXX YYYY -0000	-	1000	210	756	379	1,35	16,80	4,50	-	
11203 1100 0210 XXXX YYYY -0000	-	1100	210	832	417	1,35	18,48	4,95	-	
11203 1200 0210 XXXX YYYY -0000	-	1200	210	907	455	1,35	20,16	5,40	-	
11203 1400 0210 XXXX YYYY -0000	-	1400	210	1058	531	1,35	23,52	6,30	-	
11203 1600 0210 XXXX YYYY -0000	-	1600	210	1210	607	1,35	26,88	7,20	-	
11203 1800 0210 XXXX YYYY -0000	-	1800	210	1361	683	1,35	30,24	8,10	-	
11203 2000 0210 XXXX YYYY -0000	-	2000	210	1512	759	1,35	33,60	9,00	-	
11203 2200 0210 XXXX YYYY -0000	-	2200	210	1663	834	1,35	36,96	9,90	-	
11203 2400 0210 XXXX YYYY -0000	-	2400	210	1814	910	1,35	40,32	10,80	-	
11203 2600 0210 XXXX YYYY -0000	-	2600	210	1966	986	1,35	43,68	11,70	-	
11203 2800 0210 XXXX YYYY -0000	-	2800	210	2117	1062	1,35	47,04	12,60	-	
11203 3000 0210 XXXX YYYY -0000	-	3000	210	2268	1138	1,35	50,40	13,50	-	
11203 3300 0210 XXXX YYYY -0000	-	3300	210	2495	1252	1,35	55,44	14,85	-	
11203 3600 0210 XXXX YYYY -0000	-	3600	210	2722	1366	1,35	60,48	16,20	-	
11203 3900 0210 XXXX YYYY -0000	-	3900	210	2948	1479	1,35	65,52	17,55	-	

CE 05 in conformity with EN442-1: radiators and convectors

For heat outputs in other regimes, see p. 308 (correction factors)

PRIMULA P3 (P3/130)



P3

HOW TO ORDER P3/130

Delivery time 15 - 30 working days
(transport duration not included)

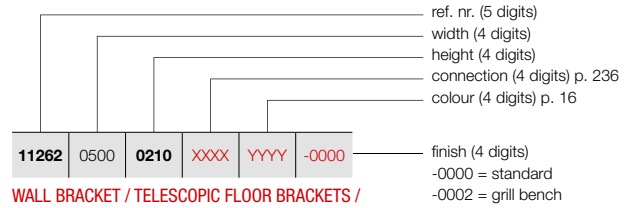

WALL BRACKET / TELESCOPIC FLOOR BRACKETS /
STEEL COLUMN FEET / WVO-SCREEN / BENCH

See p. 233 for additional accessories.

REFERENCE CODE CUSTOM MADE P3	TECHNICAL DATA									
	tubes	width (L mm)	height (H mm)	75/65/20 (Watt)	55/45/20 (Watt)	n-exp.	weight (kg)	water content (l)	electr. resistance (Watt)	
REF. NR. P3 P3/130 : 11262										
11262 0500 0210 XXXX YYYY -0000	-	500	210	560	281	1,35	11,20	2,85	-	
11262 0600 0210 XXXX YYYY -0000	-	600	210	672	337	1,35	13,44	3,42	-	
11262 0700 0210 XXXX YYYY -0000	-	700	210	784	393	1,35	15,68	3,99	-	
11262 0800 0210 XXXX YYYY -0000	-	800	210	896	450	1,35	17,92	4,56	-	
11262 0900 0210 XXXX YYYY -0000	-	900	210	1008	506	1,35	20,16	5,13	-	
11262 1000 0210 XXXX YYYY -0000	-	1000	210	1120	562	1,35	22,40	5,70	-	
11262 1100 0210 XXXX YYYY -0000	-	1100	210	1232	618	1,35	24,64	6,27	-	
11262 1200 0210 XXXX YYYY -0000	-	1200	210	1344	674	1,35	26,88	6,84	-	
11262 1400 0210 XXXX YYYY -0000	-	1400	210	1568	787	1,35	31,36	7,98	-	
11262 1600 0210 XXXX YYYY -0000	-	1600	210	1792	899	1,35	35,84	9,12	-	
11262 1800 0210 XXXX YYYY -0000	-	1800	210	2016	1012	1,35	40,32	10,26	-	
11262 2000 0210 XXXX YYYY -0000	-	2000	210	2240	1124	1,35	44,80	11,40	-	
11262 2200 0210 XXXX YYYY -0000	-	2200	210	2464	1236	1,35	49,28	12,54	-	
11262 2400 0210 XXXX YYYY -0000	-	2400	210	2688	1349	1,35	53,76	13,68	-	
11262 2600 0210 XXXX YYYY -0000	-	2600	210	2912	1461	1,35	58,24	14,82	-	
11262 2800 0210 XXXX YYYY -0000	-	2800	210	3136	1574	1,35	62,72	15,96	-	
11262 3000 0210 XXXX YYYY -0000	-	3000	210	3360	1686	1,35	67,20	17,10	-	
11262 3300 0210 XXXX YYYY -0000	-	3300	210	3696	1855	1,35	73,92	18,81	-	
11262 3600 0210 XXXX YYYY -0000	-	3600	210	4032	2023	1,35	80,64	20,52	-	
11262 3900 0210 XXXX YYYY -0000	-	3900	210	4368	2192	1,35	87,36	22,23	-	

CE₀₅ in conformity with EN442-1: radiators and convectors

For heat outputs in other regimes, see p. 308 (correction factors)

HOW TO ORDER P3/180

Delivery time 15 - 30 working days
(transport duration not included)

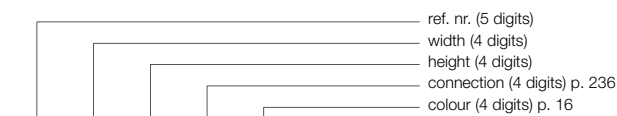

11266	0500	0210	XXXX	YYYY	-0000	finish (4 digits) -0000 = standard -0002 = grill bench
-------	------	------	------	------	-------	--

WALL BRACKET / TELESCOPIC FLOOR BRACKETS /
STEEL COLUMN FEET / WVO-SCREEN / BENCH

See p. 233 for additional accessories.

PRIMULA P3 (P3/180)



P3

REFERENCE CODE CUSTOM MADE P3	TECHNICAL DATA													
	tubes	width (L mm)	height (H mm)	75/65/20 (Watt)	55/45/20 (Watt)	n-exp.	weight (kg)	water content (l)	electr. resistance (Watt)					
REF. NR. P3 P3/180 : 11266														
11266	0500	0210	XXXX	YYYY	-0000	-	500	210	771	381	1,38	14,10	3,40	-
11266	0600	0210	XXXX	YYYY	-0000	-	600	210	925	457	1,38	16,92	4,08	-
11266	0700	0210	XXXX	YYYY	-0000	-	700	210	1079	533	1,38	19,74	4,76	-
11266	0800	0210	XXXX	YYYY	-0000	-	800	210	1233	609	1,38	22,56	5,44	-
11266	0900	0210	XXXX	YYYY	-0000	-	900	210	1387	685	1,38	25,38	6,12	-
11266	1000	0210	XXXX	YYYY	-0000	-	1000	210	1541	761	1,38	28,20	6,80	-
11266	1100	0210	XXXX	YYYY	-0000	-	1100	210	1695	838	1,38	31,02	7,48	-
11266	1200	0210	XXXX	YYYY	-0000	-	1200	210	1849	914	1,38	33,84	8,16	-
11266	1400	0210	XXXX	YYYY	-0000	-	1400	210	2157	1066	1,38	39,48	9,52	-
11266	1600	0210	XXXX	YYYY	-0000	-	1600	210	2466	1219	1,38	45,12	10,88	-
11266	1800	0210	XXXX	YYYY	-0000	-	1800	210	2774	1371	1,38	50,76	12,24	-
11266	2000	0210	XXXX	YYYY	-0000	-	2000	210	3082	1523	1,38	56,40	13,60	-
11266	2200	0210	XXXX	YYYY	-0000	-	2200	210	3390	1675	1,38	62,04	14,96	-
11266	2400	0210	XXXX	YYYY	-0000	-	2400	210	3698	1827	1,38	67,68	16,32	-
11266	2600	0210	XXXX	YYYY	-0000	-	2600	210	4007	1980	1,38	73,32	17,68	-
11266	2800	0210	XXXX	YYYY	-0000	-	2800	210	4315	2132	1,38	78,96	19,04	-
11266	3000	0210	XXXX	YYYY	-0000	-	3000	210	4623	2284	1,38	84,60	20,40	-
11266	3300	0210	XXXX	YYYY	-0000	-	3300	210	5085	2513	1,38	93,06	22,44	-
11266	3600	0210	XXXX	YYYY	-0000	-	3600	210	5548	2741	1,38	101,52	24,48	-
11266	3900	0210	XXXX	YYYY	-0000	-	3900	210	6010	2970	1,38	109,98	26,52	-

CE 05 in conformity with EN442-1: radiators and convectors

For heat outputs in other regimes, see p. 308 (correction factors)

PRIMULA P3 (P3/230)



P3

HOW TO ORDER P3/230

Delivery time 15 - 30 working days
(transport duration not included)

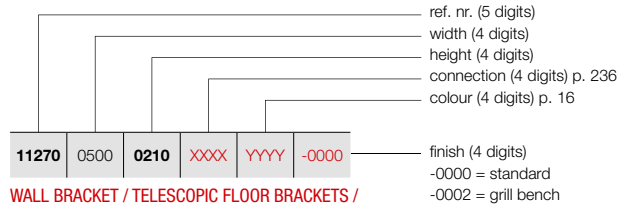

**WALL BRACKET / TELESCOPIC FLOOR BRACKETS /
STEEL COLUMN FEET / WVO-SCREEN / BENCH**

See p. 233 for additional accessories.

REFERENCE CODE CUSTOM MADE P3	TECHNICAL DATA									
	tubes	width (L mm)	height (H mm)	75/65/20 (Watt)	55/45/20 (Watt)	n-exp.	weight (kg)	water content (l)	electr. resistance (Watt)	
REF. NR. P3 P3/230 : 11270										
11270 0500 0210 XXXX YYYY -0000	-	500	210	950	472	1,37	16,85	4,25	-	
11270 0600 0210 XXXX YYYY -0000	-	600	210	1140	566	1,37	20,22	5,10	-	
11270 0700 0210 XXXX YYYY -0000	-	700	210	1330	661	1,37	23,59	5,95	-	
11270 0800 0210 XXXX YYYY -0000	-	800	210	1520	755	1,37	26,96	6,80	-	
11270 0900 0210 XXXX YYYY -0000	-	900	210	1710	849	1,37	30,33	7,65	-	
11270 1000 0210 XXXX YYYY -0000	-	1000	210	1900	944	1,37	33,70	8,50	-	
11270 1100 0210 XXXX YYYY -0000	-	1100	210	2090	1038	1,37	37,07	9,35	-	
11270 1200 0210 XXXX YYYY -0000	-	1200	210	2280	1132	1,37	40,44	10,20	-	
11270 1400 0210 XXXX YYYY -0000	-	1400	210	2660	1321	1,37	47,18	11,90	-	
11270 1600 0210 XXXX YYYY -0000	-	1600	210	3040	1510	1,37	53,92	13,60	-	
11270 1800 0210 XXXX YYYY -0000	-	1800	210	3420	1699	1,37	60,66	15,30	-	
11270 2000 0210 XXXX YYYY -0000	-	2000	210	3800	1887	1,37	67,40	17,00	-	
11270 2200 0210 XXXX YYYY -0000	-	2200	210	4180	2076	1,37	74,14	18,70	-	
11270 2400 0210 XXXX YYYY -0000	-	2400	210	4560	2265	1,37	80,88	20,40	-	
11270 2600 0210 XXXX YYYY -0000	-	2600	210	4940	2454	1,37	87,62	22,10	-	
11270 2800 0210 XXXX YYYY -0000	-	2800	210	5320	2642	1,37	94,36	23,80	-	
11270 3000 0210 XXXX YYYY -0000	-	3000	210	5700	2831	1,37	101,10	25,50	-	
11270 3300 0210 XXXX YYYY -0000	-	3300	210	6270	3114	1,37	111,21	28,05	-	
11270 3600 0210 XXXX YYYY -0000	-	3600	210	6840	3397	1,37	121,32	30,60	-	
11270 3900 0210 XXXX YYYY -0000	-	3900	210	7410	3680	1,37	131,43	33,15	-	

CE₀₅ in conformity with EN442-1: radiators and convectors

For heat outputs in other regimes, see p. 308 (correction factors)

HOW TO ORDER P3/280

Delivery time 15 - 30 working days
(transport duration not included)

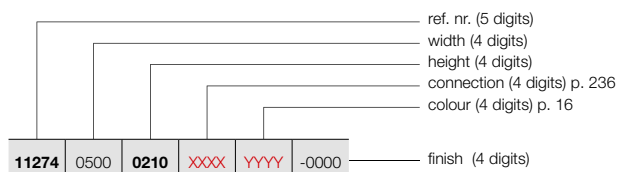

WALL BRACKET / TELESCOPIC FLOOR BRACKETS /
STEEL COLUMN FEET / WVO-SCREEN

See p. 233 for additional accessories.

PRIMULA P3 (P3/280)



P3

REFERENCE CODE CUSTOM MADE P3	TECHNICAL DATA									
	tubes	width (L mm)	height (H mm)	75/65/20 (Watt)	55/45/20 (Watt)	n-exp.	weight (kg)	water content (l)	electr. resistance (Watt)	
REF. NR. P3 P3/280 : 11274										
11274 0500 0210 XXXX YYYY -0000	-	500	210	1176	581	1,38	19,70	4,55	-	
11274 0600 0210 XXXX YYYY -0000	-	600	210	1411	697	1,38	23,64	5,46	-	
11274 0700 0210 XXXX YYYY -0000	-	700	210	1646	813	1,38	27,58	6,37	-	
11274 0800 0210 XXXX YYYY -0000	-	800	210	1881	929	1,38	31,52	7,28	-	
11274 0900 0210 XXXX YYYY -0000	-	900	210	2116	1046	1,38	35,46	8,19	-	
11274 1000 0210 XXXX YYYY -0000	-	1000	210	2351	1162	1,38	39,40	9,10	-	
11274 1100 0210 XXXX YYYY -0000	-	1100	210	2586	1278	1,38	43,34	10,01	-	
11274 1200 0210 XXXX YYYY -0000	-	1200	210	2821	1394	1,38	47,28	10,92	-	
11274 1400 0210 XXXX YYYY -0000	-	1400	210	3291	1626	1,38	55,16	12,74	-	
11274 1600 0210 XXXX YYYY -0000	-	1600	210	3762	1859	1,38	63,04	14,56	-	
11274 1800 0210 XXXX YYYY -0000	-	1800	210	4232	2091	1,38	70,92	16,38	-	
11274 2000 0210 XXXX YYYY -0000	-	2000	210	4702	2323	1,38	78,80	18,20	-	
11274 2200 0210 XXXX YYYY -0000	-	2200	210	5172	2556	1,38	86,68	20,02	-	
11274 2400 0210 XXXX YYYY -0000	-	2400	210	5642	2788	1,38	94,56	21,84	-	
11274 2600 0210 XXXX YYYY -0000	-	2600	210	6113	3021	1,38	102,44	23,66	-	
11274 2800 0210 XXXX YYYY -0000	-	2800	210	6583	3253	1,38	110,32	25,48	-	
11274 3000 0210 XXXX YYYY -0000	-	3000	210	7053	3485	1,38	118,20	27,30	-	
11274 3300 0210 XXXX YYYY -0000	-	3300	210	7758	3834	1,38	130,02	30,03	-	
11274 3600 0210 XXXX YYYY -0000	-	3600	210	8464	4182	1,38	141,84	32,76	-	

CE 05 in conformity with EN442-1: radiators and convectors

For heat outputs in other regimes, see p. 308 (correction factors)

PRIMULA P4 (P4/80)



P4

HOW TO ORDER P4/80

Delivery time 15 - 30 working days
(transport duration not included)

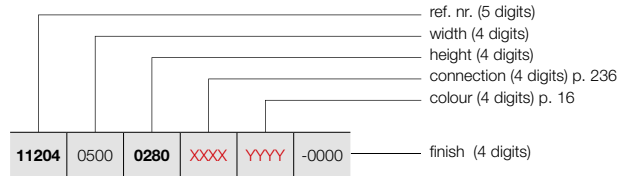

**WALL BRACKET / TELESCOPIC FLOOR BRACKETS /
STEEL COLUMN FEET / WVO-SCREEN**

See p. 233 for additional accessories.

REFERENCE CODE CUSTOM MADE P4						TECHNICAL DATA								
11204	0500	0280	XXXX	YYYY	-0000	tubes	width (L mm)	height (H mm)	75/65/20 (Watt)	55/45/20 (Watt)	n-exp.	weight (kg)	water content (l)	electr. resistance (Watt)
REF. NR. P4 P4/80 : 11204														
11204	0500	0280	XXXX	YYYY	-0000	-	500	280	435	219	1,34	11,07	3,05	-
11204	0600	0280	XXXX	YYYY	-0000	-	600	280	522	263	1,34	13,28	3,65	-
11204	0700	0280	XXXX	YYYY	-0000	-	700	280	609	307	1,34	15,50	4,26	-
11204	0800	0280	XXXX	YYYY	-0000	-	800	280	696	351	1,34	17,71	4,87	-
11204	0900	0280	XXXX	YYYY	-0000	-	900	280	783	395	1,34	19,93	5,48	-
11204	1000	0280	XXXX	YYYY	-0000	-	1000	280	870	439	1,34	22,14	6,09	-
11204	1100	0280	XXXX	YYYY	-0000	-	1100	280	957	483	1,34	24,35	6,70	-
11204	1200	0280	XXXX	YYYY	-0000	-	1200	280	1044	527	1,34	26,57	7,31	-
11204	1400	0280	XXXX	YYYY	-0000	-	1400	280	1218	614	1,34	31,00	8,53	-
11204	1600	0280	XXXX	YYYY	-0000	-	1600	280	1392	702	1,34	35,42	9,74	-
11204	1800	0280	XXXX	YYYY	-0000	-	1800	280	1566	790	1,34	39,85	10,96	-
11204	2000	0280	XXXX	YYYY	-0000	-	2000	280	1740	878	1,34	44,28	12,18	-
11204	2200	0280	XXXX	YYYY	-0000	-	2200	280	1914	965	1,34	48,71	13,40	-
11204	2400	0280	XXXX	YYYY	-0000	-	2400	280	2088	1053	1,34	53,14	14,62	-
11204	2600	0280	XXXX	YYYY	-0000	-	2600	280	2262	1141	1,34	57,56	15,83	-
11204	2800	0280	XXXX	YYYY	-0000	-	2800	280	2436	1229	1,34	61,99	17,05	-
11204	3000	0280	XXXX	YYYY	-0000	-	3000	280	2610	1316	1,34	66,42	18,27	-
11204	3300	0280	XXXX	YYYY	-0000	-	3300	280	2871	1448	1,34	73,06	20,10	-
11204	3600	0280	XXXX	YYYY	-0000	-	3600	280	3132	1580	1,34	79,70	21,92	-
11204	3900	0280	XXXX	YYYY	-0000	-	3900	280	3393	1711	1,34	86,35	23,75	-

CE₀₅ in conformity with EN442-1: radiators and convectors

For heat outputs in other regimes, see p. 308 (correction factors)

PRIMULA P4 (P4/180)



P4

HOW TO ORDER P4/180

Delivery time 15 - 30 working days
(transport duration not included)

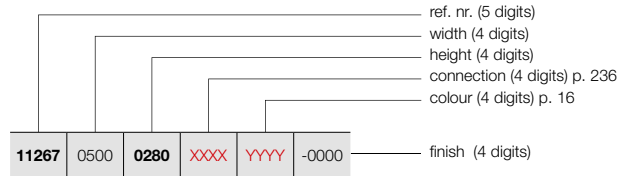

WALL BRACKET / TELESCOPIC FLOOR BRACKETS /
STEEL COLUMN FEET / WVO-SCREEN

See p. 233 for additional accessories.

REFERENCE CODE CUSTOM MADE P4	TECHNICAL DATA									
	tubes	width (L mm)	height (H mm)	75/65/20 (Watt)	55/45/20 (Watt)	n-exp.	weight (kg)	water content (l)	electr. resistance (Watt)	
REF. NR. P4 P4/180 : 11267										
11267 0500 0280 XXXX YYYY -0000	-	500	280	919	449	1,40	18,30	4,58	-	
11267 0600 0280 XXXX YYYY -0000	-	600	280	1103	539	1,40	21,96	5,49	-	
11267 0700 0280 XXXX YYYY -0000	-	700	280	1287	629	1,40	25,62	6,41	-	
11267 0800 0280 XXXX YYYY -0000	-	800	280	1470	719	1,40	29,28	7,32	-	
11267 0900 0280 XXXX YYYY -0000	-	900	280	1654	809	1,40	32,94	8,24	-	
11267 1000 0280 XXXX YYYY -0000	-	1000	280	1838	899	1,40	36,60	9,15	-	
11267 1100 0280 XXXX YYYY -0000	-	1100	280	2022	989	1,40	40,26	10,07	-	
11267 1200 0280 XXXX YYYY -0000	-	1200	280	2206	1079	1,40	43,92	10,98	-	
11267 1400 0280 XXXX YYYY -0000	-	1400	280	2573	1258	1,40	51,24	12,81	-	
11267 1600 0280 XXXX YYYY -0000	-	1600	280	2941	1438	1,40	58,56	14,64	-	
11267 1800 0280 XXXX YYYY -0000	-	1800	280	3308	1618	1,40	65,88	16,47	-	
11267 2000 0280 XXXX YYYY -0000	-	2000	280	3676	1798	1,40	73,20	18,30	-	
11267 2200 0280 XXXX YYYY -0000	-	2200	280	4044	1978	1,40	80,52	20,13	-	
11267 2400 0280 XXXX YYYY -0000	-	2400	280	4411	2157	1,40	87,84	21,96	-	
11267 2600 0280 XXXX YYYY -0000	-	2600	280	4779	2337	1,40	95,16	23,79	-	
11267 2800 0280 XXXX YYYY -0000	-	2800	280	5146	2517	1,40	102,48	25,62	-	
11267 3000 0280 XXXX YYYY -0000	-	3000	280	5514	2697	1,40	109,80	27,45	-	
11267 3300 0280 XXXX YYYY -0000	-	3300	280	6065	2966	1,40	120,78	30,20	-	
11267 3600 0280 XXXX YYYY -0000	-	3600	280	6617	3236	1,40	131,76	32,94	-	
11267 3900 0280 XXXX YYYY -0000	-	3900	280	7168	3506	1,40	142,74	35,69	-	

CE₀₅ in conformity with EN442-1: radiators and convectors

For heat outputs in other regimes, see p. 308 (correction factors)

HOW TO ORDER P4/230

Delivery time 15 - 30 working days
(transport duration not included)

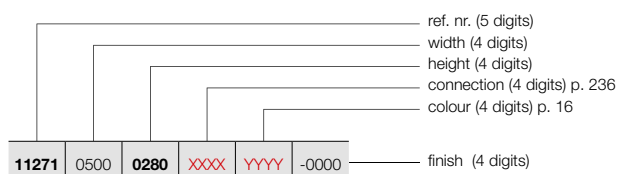

WALL BRACKET / TELESCOPIC FLOOR BRACKETS /
STEEL COLUMN FEET / WVO-SCREEN

See p. 233 for additional accessories.

PRIMULA P4 (P4/230)



P4

REFERENCE CODE CUSTOM MADE P4	TECHNICAL DATA									
	tubes	width (L mm)	height (H mm)	75/65/20 (Watt)	55/45/20 (Watt)	n-exp.	weight (kg)	water content (l)	electr. resistance (Watt)	
REF. NR. P4 P4/230 : 11271										
11271 0500 0280 XXXX YYYY -0000	-	500	280	1129	552	1,40	21,83	5,78	-	
11271 0600 0280 XXXX YYYY -0000	-	600	280	1355	663	1,40	26,19	6,93	-	
11271 0700 0280 XXXX YYYY -0000	-	700	280	1581	773	1,40	30,56	8,09	-	
11271 0800 0280 XXXX YYYY -0000	-	800	280	1806	883	1,40	34,92	9,24	-	
11271 0900 0280 XXXX YYYY -0000	-	900	280	2032	994	1,40	39,29	10,40	-	
11271 1000 0280 XXXX YYYY -0000	-	1000	280	2258	1104	1,40	43,65	11,55	-	
11271 1100 0280 XXXX YYYY -0000	-	1100	280	2484	1215	1,40	48,02	12,71	-	
11271 1200 0280 XXXX YYYY -0000	-	1200	280	2710	1326	1,40	52,38	13,86	-	
11271 1400 0280 XXXX YYYY -0000	-	1400	280	3161	1546	1,40	61,11	16,17	-	
11271 1600 0280 XXXX YYYY -0000	-	1600	280	3613	1767	1,40	69,84	18,48	-	
11271 1800 0280 XXXX YYYY -0000	-	1800	280	4064	1988	1,40	78,57	20,79	-	
11271 2000 0280 XXXX YYYY -0000	-	2000	280	4516	2209	1,40	87,30	23,10	-	
11271 2200 0280 XXXX YYYY -0000	-	2200	280	4968	2430	1,40	96,03	25,41	-	
11271 2400 0280 XXXX YYYY -0000	-	2400	280	5419	2651	1,40	104,76	27,72	-	
11271 2600 0280 XXXX YYYY -0000	-	2600	280	5871	2872	1,40	113,49	30,03	-	
11271 2800 0280 XXXX YYYY -0000	-	2800	280	6322	3092	1,40	122,22	32,34	-	
11271 3000 0280 XXXX YYYY -0000	-	3000	280	6774	3313	1,40	130,95	34,65	-	
11271 3300 0280 XXXX YYYY -0000	-	3300	280	7451	3644	1,40	144,05	38,12	-	

CE 05 in conformity with EN442-1: radiators and convectors

For heat outputs in other regimes, see p. 308 (correction factors)

PRIMULA P4 (P4/280)



P4

HOW TO ORDER P4/280

Delivery time 15 - 30 working days
(transport duration not included)

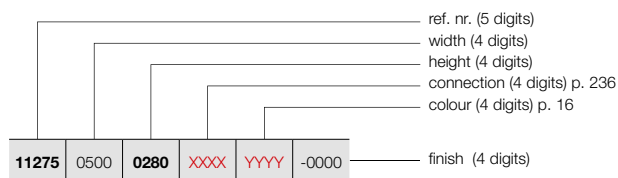

WALL BRACKET / TELESCOPIC FLOOR BRACKETS /
STEEL COLUMN FEET / WVO-SCREEN

See p. 233 for additional accessories.

REFERENCE CODE CUSTOM MADE P4	TECHNICAL DATA									
	tubes	width (L mm)	height (H mm)	75/65/20 (Watt)	55/45/20 (Watt)	n-exp.	weight (kg)	water content (l)	electr. resistance (Watt)	
REF. NR. P4 P4/280 : 11275										
11275 0500 0280 XXXX YYYY -0000	-	500	280	1335	653	1,40	25,55	6,13	-	
11275 0600 0280 XXXX YYYY -0000	-	600	280	1602	784	1,40	30,66	7,35	-	
11275 0700 0280 XXXX YYYY -0000	-	700	280	1869	914	1,40	35,77	8,58	-	
11275 0800 0280 XXXX YYYY -0000	-	800	280	2136	1045	1,40	40,88	9,80	-	
11275 0900 0280 XXXX YYYY -0000	-	900	280	2403	1175	1,40	45,99	11,03	-	
11275 1000 0280 XXXX YYYY -0000	-	1000	280	2670	1306	1,40	51,10	12,25	-	
11275 1100 0280 XXXX YYYY -0000	-	1100	280	2937	1437	1,40	56,21	13,48	-	
11275 1200 0280 XXXX YYYY -0000	-	1200	280	3204	1567	1,40	61,32	14,70	-	
11275 1400 0280 XXXX YYYY -0000	-	1400	280	3738	1828	1,40	71,54	17,15	-	
11275 1600 0280 XXXX YYYY -0000	-	1600	280	4272	2090	1,40	81,76	19,60	-	
11275 1800 0280 XXXX YYYY -0000	-	1800	280	4806	2351	1,40	91,98	22,05	-	
11275 2000 0280 XXXX YYYY -0000	-	2000	280	5340	2612	1,40	102,20	24,50	-	
11275 2200 0280 XXXX YYYY -0000	-	2200	280	5874	2873	1,40	112,42	26,95	-	
11275 2400 0280 XXXX YYYY -0000	-	2400	280	6408	3134	1,40	122,64	29,40	-	
11275 2600 0280 XXXX YYYY -0000	-	2600	280	6942	3395	1,40	132,86	31,85	-	
11275 2800 0280 XXXX YYYY -0000	-	2800	280	7476	3657	1,40	143,08	34,30	-	

CE in conformity with EN442-1: radiators and convectors

For heat outputs in other regimes, see p. 308 (correction factors)

PRIMULA FREE-STANDING INSTALLATION
IN OPTION

LENGTH IN MM NUMBER NEEDED PER PLINTH	COLOUR	REF. NR. P/80	REF. NR. P/130	REF. NR. P/180	REF. NR. P/230	REF. NR. P/280
---	--------	------------------	-------------------	-------------------	-------------------	-------------------

**STEEL COLUMN
FEET**



500 - 1800: 2	RAL 9016	118621200009016	118622200009016	118623200009016	118624200009016	118625200009016
	COLOUR	11862120000xxxx	11862220000xxxx	11862320000xxxx	11862420000xxxx	11862520000xxxx
2000 - 2400: 3	RAL 9016	118621300009016	118622300009016	118623300009016	118624300009016	118625300009016
	COLOUR	11862130000xxxx	11862230000xxxx	11862330000xxxx	11862430000xxxx	11862530000xxxx
2600 - 3600: 4	RAL 9016	118621400009016	118622400009016	118623400009016	118624400009016	118625400009016
	COLOUR	11862140000xxxx	11862240000xxxx	11862340000xxxx	11862440000xxxx	11862540000xxxx
3900: 5	RAL 9016	118621500009016	118622500009016	118623500009016	118624500009016	118625500009016
	COLOUR	11862150000xxxx	11862250000xxxx	11862350000xxxx	11862450000xxxx	11862550000xxxx

Steel column feet enable to fix a thermostatic valve. The standard height of the feet is 150 mm. Possible for all connections except for connection 11 and 88.
Number of column feet needed = number of telescopic feet needed.

ACCESSORIES	REF. NR. P1	REF. NR. P2	REF. NR. P3	REF. NR. P4	COLOUR
-------------	----------------	----------------	----------------	----------------	--------

WVO-SCREEN



1186301xxx9016 1186302xxx9016 1186303xxx9016 1186304xxx9016
1186301xxxxxxx 1186302xxxxxxx 1186303xxxxxxx 1186304xxxxxxx

RAL 9016
COLOUR

The WVO-screen is delivered separately and can easily be mounted on the plinth radiator. The WVO-screen is included in the WVO-screen price. Please indicate the length in the reference number when ordering (0500/0600/...).

* Prices see table P1/P2/P3/P4.

ACCESSORIES	PLINTH LENGTH	NUMBER OF PIECES	REF. NR. P/80	REF. NR. P/130	REF. NR. P/180	REF. NR. P/230	REF. NR. P/280
-------------	---------------	---------------------	------------------	-------------------	-------------------	-------------------	-------------------

BENCH



P1	RAL 9016	500-1800	set 2x	-	118642200009016	118643200009016	118644200009016	-
	COLOUR			-	11864220000xxxx	11864320000xxxx	11864420000xxxx	-
	RAL 9016	2000-2400	set 3x	-	118642300009016	118643300009016	118644300009016	-
	COLOUR			-	11864230000xxxx	11864330000xxxx	11864430000xxxx	-
	RAL 9016	2600-3600	set 4x	-	118642400009016	118643400009016	118644400009016	-
	COLOUR			-	11864240000xxxx	11864340000xxxx	11864440000xxxx	-
	RAL 9016	3900	set 5x	-	118642500009016	118643500009016	118644500009016	-
	COLOUR			-	11864250000xxxx	11864350000xxxx	11864450000xxxx	-
P2	RAL 9016	500-1800	set 2x	-	118652200009016	118653200009016	118654200009016	-
	COLOUR			-	11865220000xxxx	11865320000xxxx	11865420000xxxx	-
	RAL 9016	2000-2400	set 3x	-	118652300009016	118653300009016	118654300009016	-
	COLOUR			-	11865230000xxxx	11865330000xxxx	11865430000xxxx	-
	RAL 9016	2600-3600	set 4x	-	118652400009016	118653400009016	118654400009016	-
	COLOUR			-	11865240000xxxx	11865340000xxxx	11865440000xxxx	-
	RAL 9016	3900	set 5x	-	118652500009016	118653500009016	118654500009016	-
	COLOUR			-	11865250000xxxx	11865350000xxxx	11865450000xxxx	-
P3	RAL 9016	500-1800	set 2x	-	118662200009016	118663200009016	118664200009016	-
	COLOUR			-	11866220000xxxx	11866320000xxxx	11866420000xxxx	-
	RAL 9016	2000-2400	set 3x	-	118662300009016	118663300009016	118664300009016	-
	COLOUR			-	11866230000xxxx	11866330000xxxx	11866430000xxxx	-
	RAL 9016	2600-3600	set 4x	-	118662400009016	118663400009016	118664400009016	-
	COLOUR			-	11866240000xxxx	11866340000xxxx	11866440000xxxx	-
	RAL 9016	3900	set 5x	-	118662500009016	118663500009016	118664500009016	-
	COLOUR			-	11866250000xxxx	11866350000xxxx	11866450000xxxx	-

The bench supports have to be ordered together with the plinth radiator. The bench parts are not sold separately.

A set consists of 1 steel column foot 'X' and 1 bench support 'Y'. The wooden shelves for the bench are not available from Vasco. The connections are the same as the connections for steel column foot plinth radiators. A plinth radiator with a bench is available with WVO-screen. All models are supplied with a grill*.

* Please indicate **code -0002** for "Finish" when ordering. Mounting accessories for benches are delivered together with the mounting instructions with the positions of the wholes for the wooden bench.

X : 141 mm
Y : P1 = 211 mm
P2 = 141 mm
P3 = 71 mm

Possible for the following plinth radiators:

type	depth	width	type	depth	width	type	depth	width
P1-130	130	500-3900	P2-130	130	500-3900	P3-130	130	500-3900
P1-180	180	500-3900	P2-180	180	500-3900	P3-180	180	500-3900
P1-230	230	500-3900	P2-230	230	500-3900	P3-230	230	500-3900

PRIMULA: P2 (STOCK)

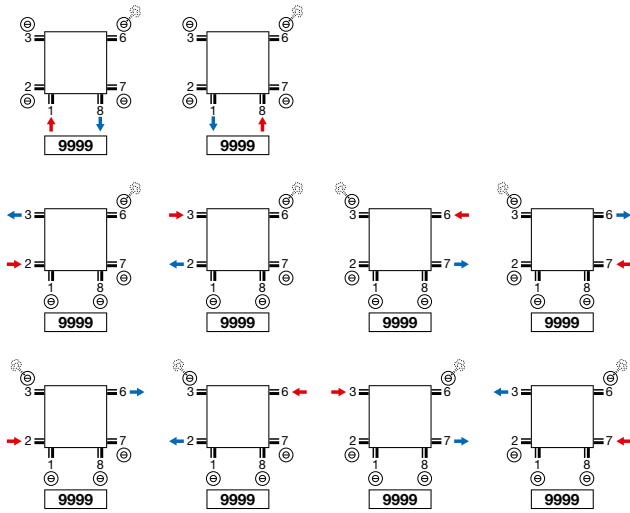

- P2 universal connection 6 x ½ (1, 2, 3, 6, 7, 8)
- ATTENTION: TWO-PIPE SYSTEM: not possible for type P2/80: 11, 88, 22, 77

PRIMULA: P1 / P2 / P3 / P4 (NON STOCK)

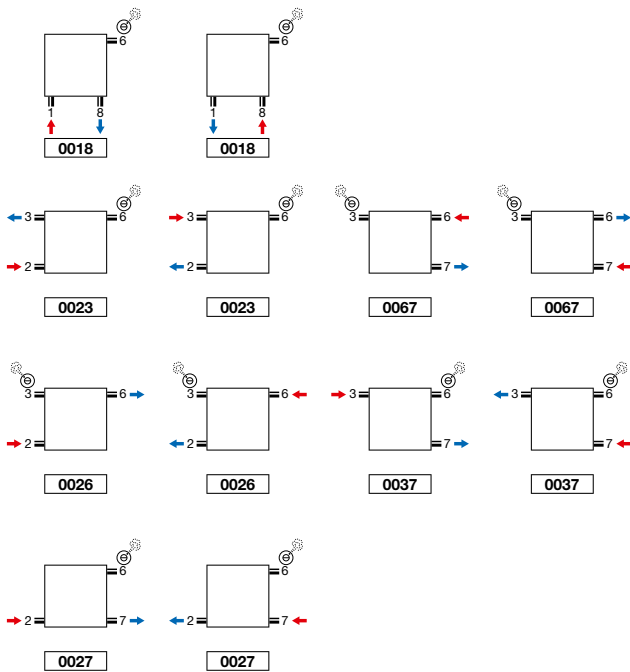

- P2, P3, P4 universal connection 6 x ½ (1, 2, 3, 6, 7, 8)
- P1 universal connection 4 x ½ (1, 3, 6, 8)
- ATTENTION: TWO-PIPE SYSTEM:
 - not possible for types P1/80, P2/80, P3/80, P4/80: 11, 88, 22, 77
 - not possible for type P1: 23, 32, 67, 76

Attention: connecting the radiator can only be as shown by the connecting icons. For any other connection method, we take no responsibility.